



\* Construye los Pop-Ups a 90° a partir de los gráficos siguientes, que representan láminas desplegadas donde las líneas rojas indican pliegues en valle, las verdes indican pliegues en montaña y las negras representan cortes.



FIGURA 01



FIGURA 02

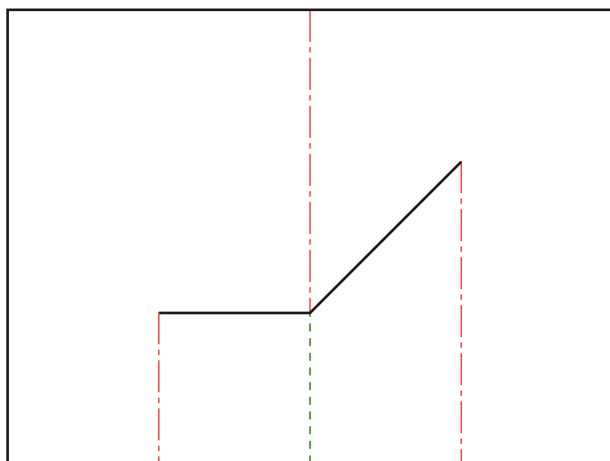

FIGURA 03

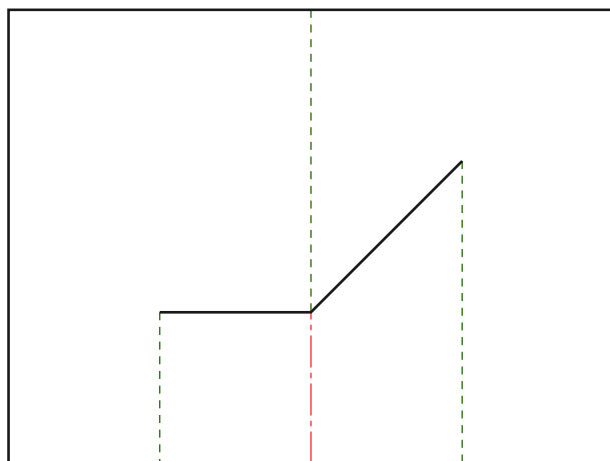

FIGURA 04

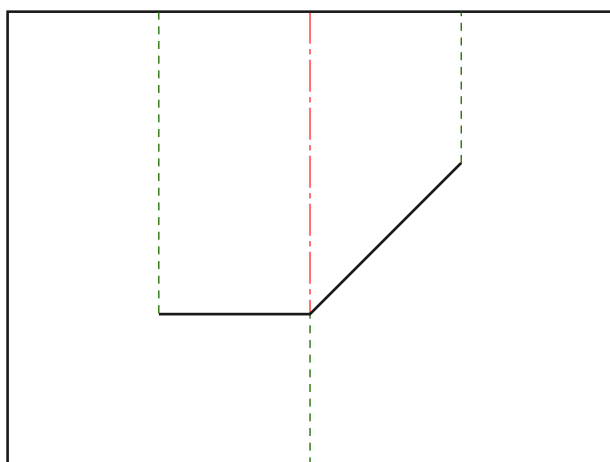

FIGURA 05

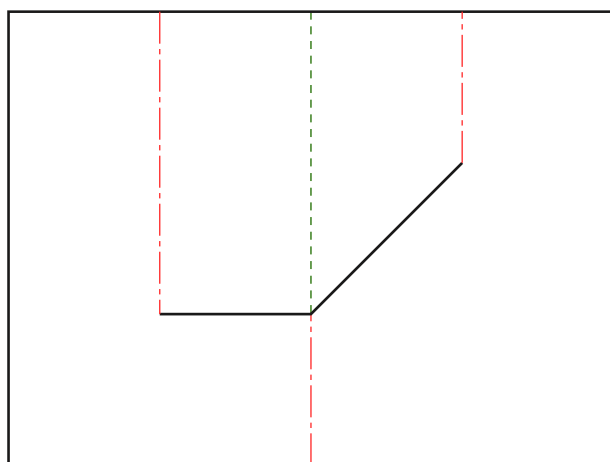

FIGURA 06

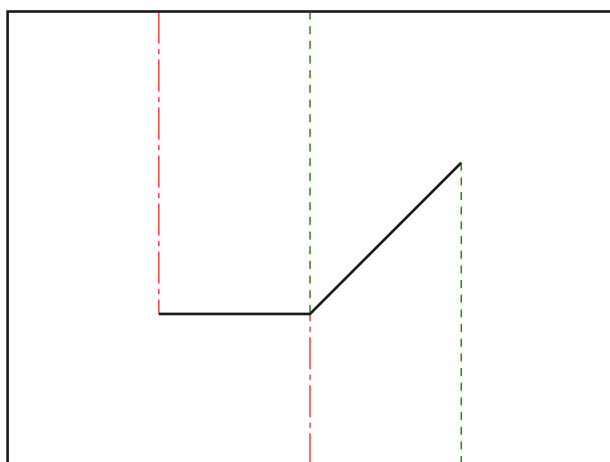

FIGURA 07

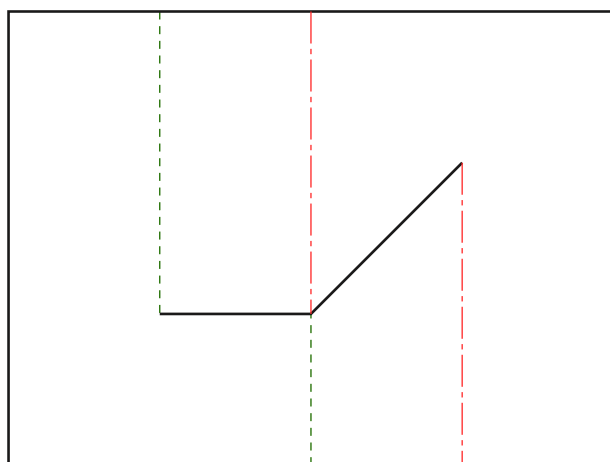

FIGURA 08

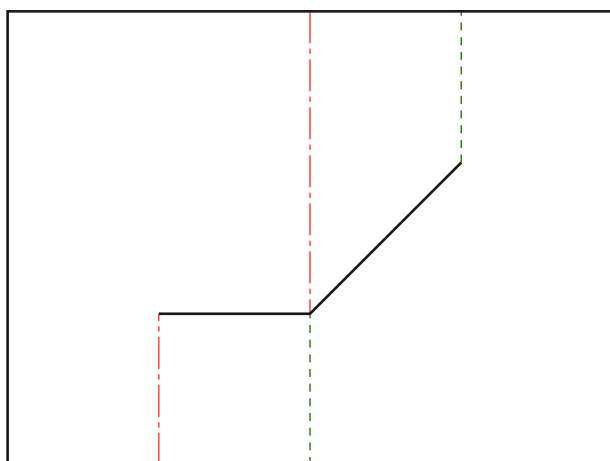

\* Construye 8 Pop-Ups a 90° diferentes a partir de los gráficos siguientes, que representan láminas desplegadas donde las líneas negras representan cortes, teniendo en cuenta las reglas 3x1 y 2x2 para definir los pliegues en valle y los pliegues en montaña.

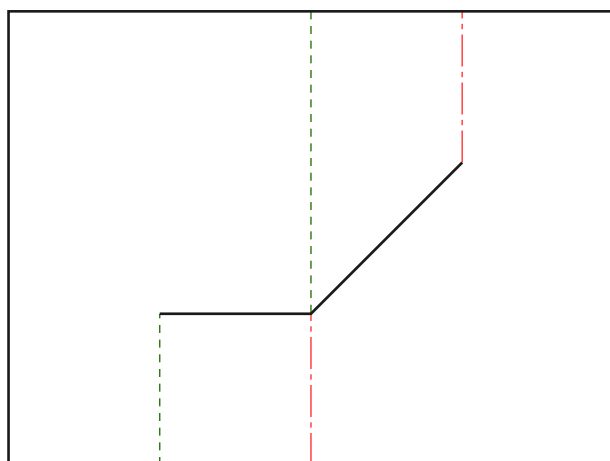

FIGURA 01



FIGURA 02

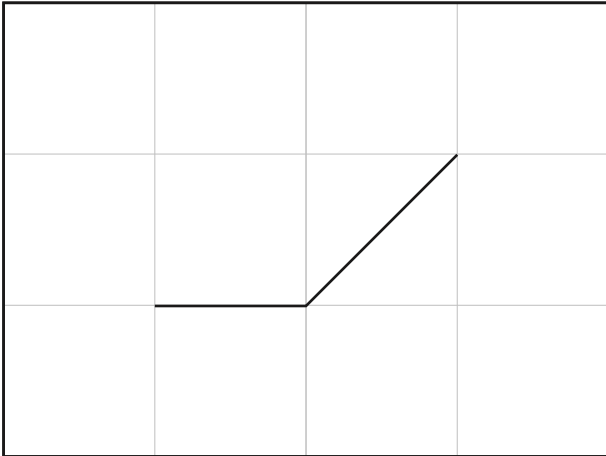

FIGURA 03

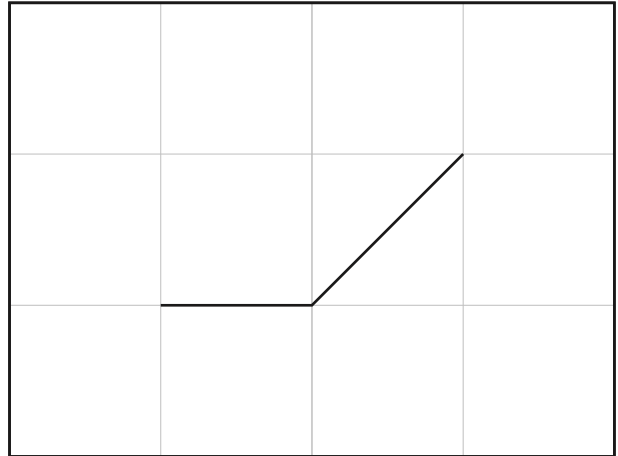

FIGURA 04

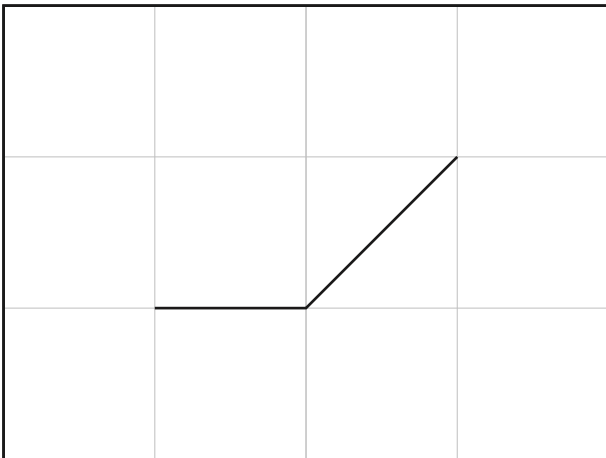

FIGURA 05

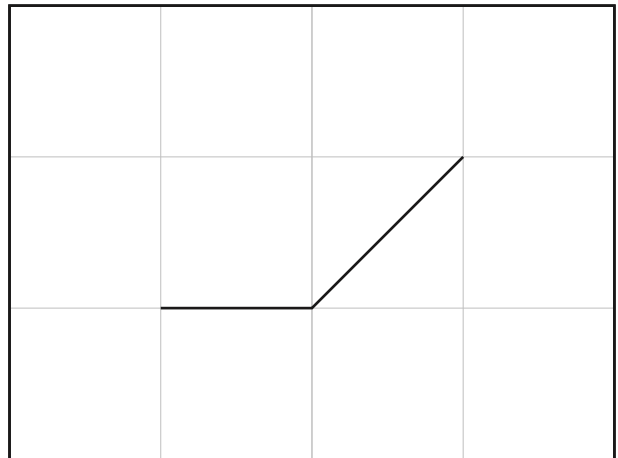

FIGURA 06

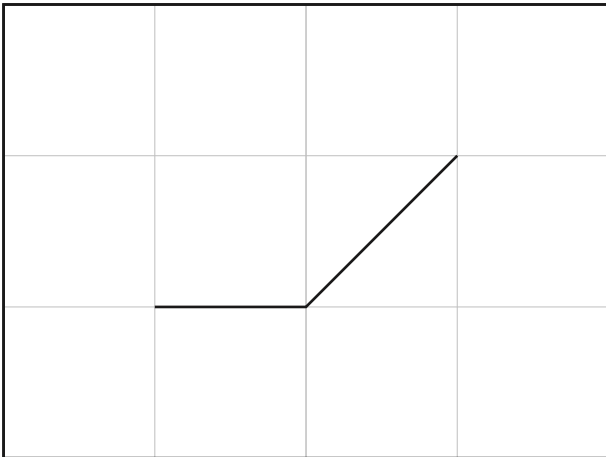

FIGURA 07

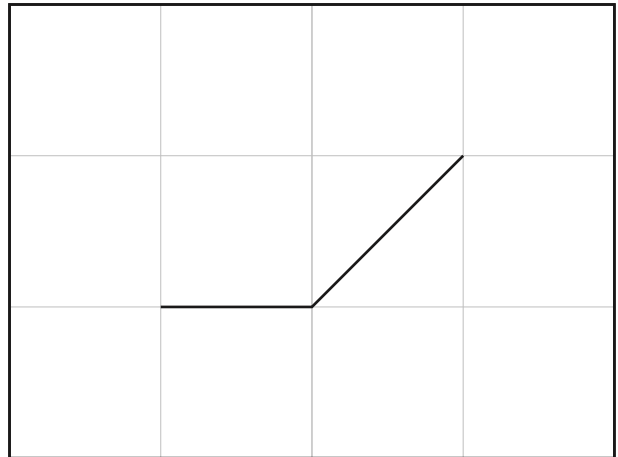
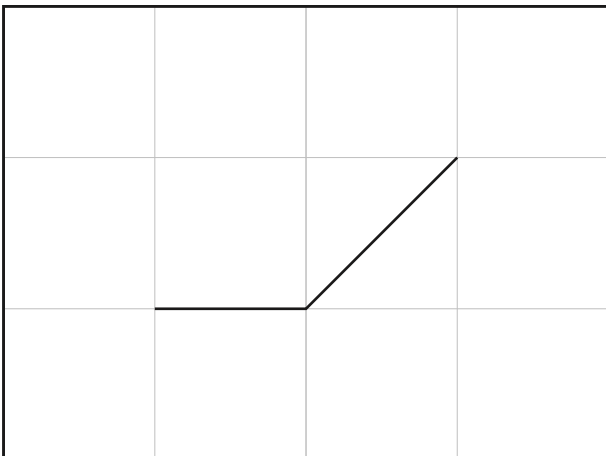
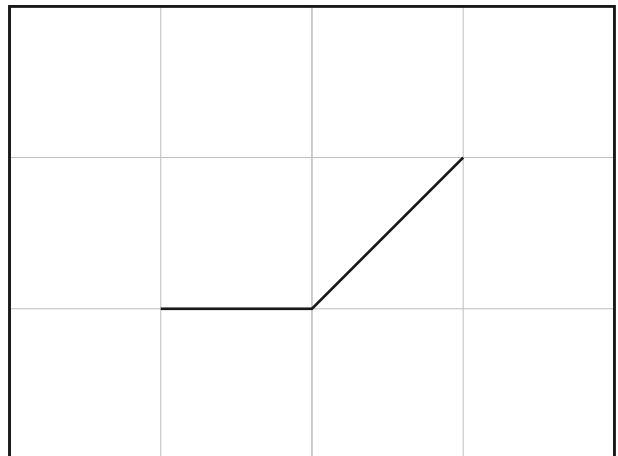

FIGURA 08